

# 2.01

## Alati i pribor



# Električni alati

**Br. artikla**   **Opis artikla**

**6024020** Bosch GSR 10,8-2-Li, aku bušilica/izvijač (2x1,5 Ah, punjač)

JM kom

**Br. artikla**   **Opis artikla**

**6024022** Bosch GSR 1800-Li Prof., aku bušilica/izvijač 18V (2x1,5 Ah, punjač, kovčeg)

JM kom

**Br. artikla**   **Opis artikla**

**6024021** Bosch GSB 13 RE udarna bušilica 600W

JM kom

**Br. artikla**   **Opis artikla**

**6010056** Makita brus. vibrac. B03710 (190W, 93x185mm)

JM kom

**Br. artikla**   **Opis artikla**

**6010057** Makita brus. ekcentar B06030 (310W, 150mm)

JM kom

**Br. artikla**   **Opis artikla**

**6010013** Makita bušilica 6413 (450W, 10mm.bsz.l/r)

JM kom

**Br. artikla**   **Opis artikla**

**6010820** Makita aku buš-izv DF457DWE (18V, 1.3Ah, Li-ion)

JM kom



**Br. artikla** Opis artikla

**6010066** Makita aku buš.-izv. DF330DWLE  
(10.8V, Li-Ion)

JM kom

# Ručni alati

**Br. artikla** Opis artikla

**6010045** MAKITA glodalica za lamele "keksarica" PJ7000J  
(590W, 100 mm)

JM kom

**Br. artikla** Opis artikla

**6022500** Bosch laserski daljinomjer GLM 30

JM kom

**Br. artikla** Opis artikla

**6010023** Makita ubodna pila 4327  
(450W.elek)

JM kom

**Br. artikla** Opis artikla

**6121115** Svrdlo za drvo šarnir 15 mm

**6121120** Svrdlo za drvo šarnir 20 mm

**6121135** Svrdlo za drvo šarnir 35 mm

JM kom

**Br. artikla** Opis artikla

**6010032** Makita ubodna pila 4351 FCT (720W)

JM kom

**Br. artikla** Opis artikla

**6121001** Svrdlo za drvo Ø 3x30 mm

**6121002** Svrdlo za drvo Ø 4x40 mm

**6121003** Svrdlo za drvo Ø 5x45 mm

**6121004** Svrdlo za drvo Ø 6x50 mm

**6121006** Svrdlo za drvo Ø 8x65 mm

**6121008** Svrdlo za drvo Ø 10x75 mm

**6121009** Svrdlo za drvo Ø 12x95 mm

JM kom



Cijene artikala dostupne su skeniranjem QR koda  
ili na web stranici [www.elgrad.hr](http://www.elgrad.hr)

**Br. artikla** **Opis artikla**

**6110051** BGS stezna glava 13mm, 1/2"  
+ SDS adapter, 9937

JM kom

**Br. artikla** **Opis artikla**

**6110052** BGS kutna glava, 4847

JM kom

**Br. artikla** **Opis artikla**

**6110053** BGS kutni nastavak, 20801

JM kom

**Br. artikla** **Opis artikla**

**6110076** Makita kruna bimetal 60 mm D-25688

**6110077** Makita držač bim. krune  
32-152mm D-17186

**6110078** Makita kruna bimetal 80 mm D-33869

JM kom

**Br. artikla** **Opis artikla**

**6023200\*** 2,5 x 74 mm - T101BR - tvrdo i meko drvo,  
oplemenjena iverica 3-30 mm - fini rez

**6023201** 3 x 91 mm T301CD - tvrdo i meko drvo,  
oplemenjena iverica 10-65 mm - za deblje ploče

**6023202** 1,4 x 56 mm T101A0 - tvrdo i meko drvo,  
oplemenjena iverica 1.5 - 15 mm za krivolinijski  
rez

**6023203** 2,5 x 74 mm T101B - tvrdo i meko drvo,  
oplemenjena iverica 3-30 mm,  
PVC i Epoxy cijevi do Ø30 mm

JM pak \*set = 5 kom

**Br. artikla** **Opis artikla**

**6023150** Bosch 32-dijelni set bitova izvijača PRO

JM set

**Br. artikla** **Opis artikla**

**6110002** Makita set 28-dij. svrdla i bitovi, P-64808

JM set



**Br. artikla** Opis artikla**6023001** BIT ExtraHard PZ1x25 mm, Bosch**6023002** BIT ExtraHard PZ2x25 mm, Bosch**6023003** BIT ExtraHard PZ3x25 mm, Bosch

JM kom

**Br. artikla** Opis artikla**6023010** BIT INBUS 3, 1/4", l = 25 mm**6023011** BIT INBUS 4, 1/4"

JM kom

**Br. artikla** Opis artikla**6110060** BGS magnetni držač bitova

JM kom

**Br. artikla** Opis artikla**6021120** Strugač PVC s nožem

JM kom

**Br. artikla** Opis artikla**6110061** BGS probijač rupa 35 mm, 562**6040126** Graničnik bušenja za svrdlo ø5 mm

JM kom

**Br. artikla** Opis artikla**6121040** Graničnici dubine bušenja, ø 6-8-10 mm (set)

JM set

**Br. artikla** Opis artikla**6121041** Označivač ø 6 mm, 4/1**6121042** Označivač ø 8 mm, 4/1**6121043** Označivač ø 10 mm, 4/1

JM set set = 4 kom

**Br. artikla** Opis artikla**6040100** TCT-Bormax set svrdala za drvo ø 15,20,25,30 i 35 mm**6040101** TCT-Bormax svrdlo za drvo ø 15 mm**6040102** TCT-Bormax svrdlo za drvo ø 20 mm**6040103** TCT-Bormax svrdlo za drvo ø 35 mm

JM kom





**Br. artikla** **Opis artikla**

**6040110** Set svrdala za drvo  $\varnothing$  3,4,5,6 i 8 mm sa bit prihvatom

JM kom

**Br. artikla** **Opis artikla**

**6040113** HSS svrdlo za drvo  $\varnothing$  3 mm

**6040114** HSS svrdlo za drvo  $\varnothing$  4 mm

**6040115** HSS svrdlo za drvo  $\varnothing$  5 mm

**6040118** HSS svrdlo za drvo  $\varnothing$  8 mm

**6040119** HSS svrdlo za drvo  $\varnothing$  9 mm

**6040120** HSS svrdlo za drvo  $\varnothing$  10 mm

**6040121** HSS svrdlo za drvo  $\varnothing$  11 mm

**6040122** HSS svrdlo za drvo  $\varnothing$  11,5 mm

**6040123** HSS svrdlo za drvo  $\varnothing$  12 mm

**6040124** HSS svrdlo za drvo  $\varnothing$  14 mm

**6040125** Set svrdala za drvo  $\varnothing$  3,4,5,6 i 8 mm sa cilindričnim prihvatom

JM kom

**Br. artikla** **Opis artikla**

**6040128** Rezervno svrdlo za predbušenje,  $\varnothing$  2,75 mm

**6040129** Svrdlo za predbušenje sa vodilicom

JM kom

**Br. artikla** **Opis artikla**

**6040130** Svrdlo za konfirmat vijke

JM kom

**Br. artikla** **Opis artikla**

**6040131** Strojni upuštač  $\varnothing$  16 mm

JM kom

**Br. artikla** **Opis artikla**

**6040134** Strojni upuštač  $\varnothing$  16 mm sa bit prihvatom

JM kom

**Br. artikla** **Opis artikla**

**6040135** Strojni upuštač  $\varnothing$  16 mm za svrdlo  $\varnothing$  5 mm

JM kom



**Br. artikla** Opis artikla

**6040139** Ručni upuštač ø 16 mm,  
plastična drška

JM kom

**Br. artikla** Opis artikla

**6040142** Krunska pila sa TM zubima ø60 mm

**6040144** Krunska pila sa TM zubima ø80 mm

**6040146** Krunska pila sa TM zubima ø105 mm

**6040148** Krunska pila sa TM zubima ø133 mm

**6040150** Nosač krunske pile sa izbacivačem

JM kom

**Br. artikla** Opis artikla

**6040151** Ravno glodalo dvoperno ø 8 mm,  
L= 51mm, B= 19mm

**6040152** Ravno glodalo dvoperno ø 10 mm,  
L= 51mm, B= 19mm

**6040153** Ravno glodalo dvoperno ø 12 mm,  
L= 51mm, B= 19mm

**6040154** Ravno glodalo dvoperno ø 14 mm,  
L= 51mm, B= 19mm

**6040155** Ravno glodalo dvoperno ø 16 mm,  
L= 51mm, B= 19mm

**6040156** Ravno glodalo dvoperno ø 12 mm dulje, L= 63mm,  
B= 32mm

JM kom

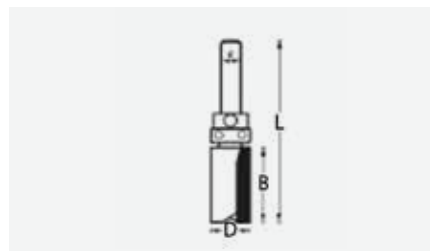
**Br. artikla** Opis artikla

**6040159** Kopirno glodalo ø 15,9 mm, ležaj gore,  
L= 63mm, B= 25,4 mm

JM kom

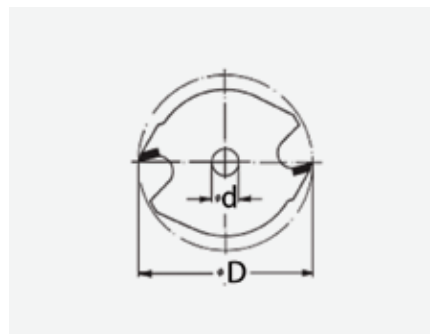
**Br. artikla** Opis artikla

**6040162** Pilasto glodalo  
B=2,5 mm, D= 40 mm, d= 6,35 mm

**6040163** Pilasto glodalo  
B= 3 mm, D= 40mm, d= 6,35mm

**6040164** Pilasto glodalo  
B=3,5 mm, D= 40mm, d= 6,35 mm

**6040165** Pilasto glodalo  
B=4 mm, D= 40mm, d=6,35 mm

JM kom

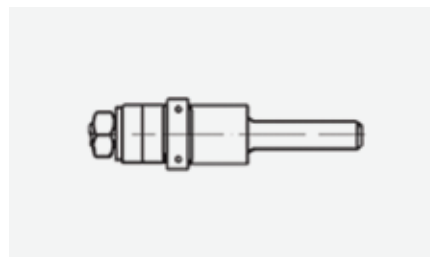
**Br. artikla** Opis artikla

**6040169** Nosač pilastog glodala sa ležajem,  
D= 15,9mm, B= 58mm

JM kom

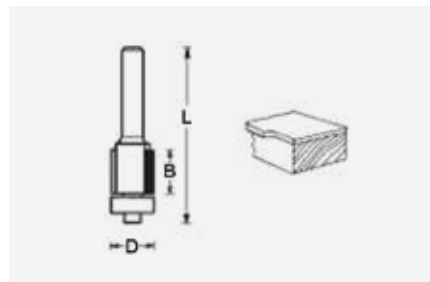
**Br. artikla** Opis artikla

**6040172** Kopirno glodalo ø 12,7 mm, l=12,7 mm, ležaj  
dolje, B=12,7 mm, L= 60mm

**6040173** Kopirno glodalo ø 12,7 mm, l=25,4 mm, ležaj  
dolje, B= 25,4mm, L=70mm

JM kom

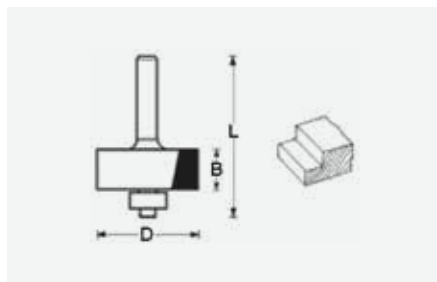

**Br. artikla** Opis artikla

**6040175** Glodalo za leđa  $\varnothing$  31,7 mm sa ležajem,  
B= 12,7 mm, L=51 mm

JM kom

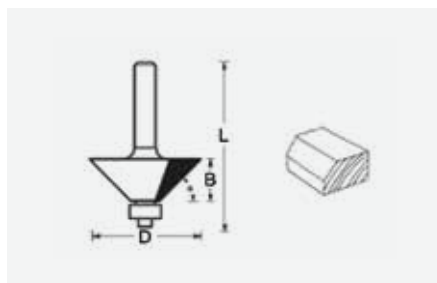
**Br. artikla** Opis artikla

**6040176** Glodalo 45° sa ležajem,  
D=31,8mm, B=12,7mm, L=53mm

JM kom

**Br. artikla** Opis artikla

**6040181** Glodalo r=3 mm sa ležajem,  
D= 18,7 mm, B= 9,5mm, L= 49 mm

**6040182** Glodalo r=4 mm sa ležajem,  
D=20,7 mm, B=9,5mm, L=49 mm

**6040183** Glodalo r=6,4 mm sa ležajem,  
D= 25,4mm, B= 12,7mm, L=51mm

**6040184** Glodalo r=8 mm sa ležajem,  
D= 28,6mm, B= 12,7mm, L=51mm

JM kom

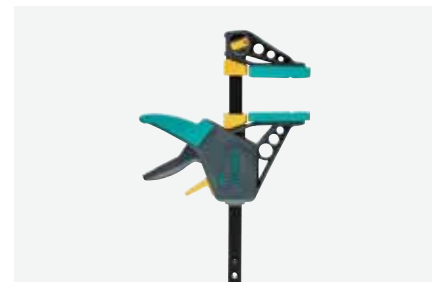
**Br. artikla** Opis artikla

**6130009** Stega stolarska Quick PRO 100-150 Wolcraft

**6130010** Stega stolarska Quick PRO 100-300 Wolcraft

**6130011** Stega stolarska Quick PRO 100-450 Wolcraft

**6130012** Stega stolarska Quick PRO 100-700 Wolcraft

**6130013** Stega stolarska Quick PRO 100-915 Wolcraft

JM kom

**Br. artikla** Opis artikla

**6130005** Strugač plastični 61 mm Wolcraft

JM kom

**Br. artikla** Opis artikla

**6130006** Kutnik univerzalni 300 mm Wolcraft

JM kom

**Br. artikla** Opis artikla

**6130003** Držač bit nastavaka s magnetom i prstenom  
Wolcraft

JM kom





**Br. artikla** Opis artikla

6130004 Skalpel 18 mm Wolcraft

JM kom

**Br. artikla** Opis artikla

6130007 Odvijač drška + 5 bitova 6 dij. Wolcraft

JM kom

**Br. artikla** Opis artikla

6130008 Kutija s listovima za ubodnu pilu Wolcraft

JM kom

**Br. artikla** Opis artikla

6130014 Stega s računom FZR 60 Wolcraft

JM kom

# Šablone

**Br. artikla** Opis artikla

6121045 Šablona za tiplanje, PVC Bosch

JM kom

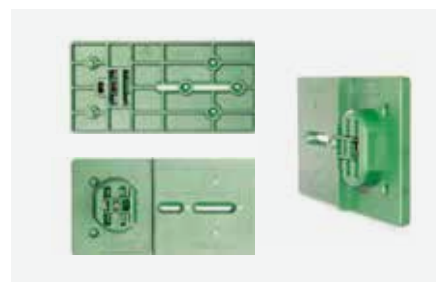
**Br. artikla** Opis artikla

6075865 Šablona za Grass spojnice i pločice

JM kom

**Br. artikla** Opis artikla

6075776 Šablona za bušenje Tiomos i Nexis spojnica, 45/9,5

JM kom



Cijene artikala dostupne su skeniranjem QR koda  
ili na web stranici [www.elgrad.hr](http://www.elgrad.hr)

**Br. artikla** **Opis artikla**

**6072050** Šablona za označavanje fronti Nova Pro ladica, h=90 i h=122

**6071908** Šablona za označavanje fronti Nova Pro ladica, h=186 i h=250

JM kom

**Br. artikla** **Opis artikla**

**6071346** Šablona za označavanje Nova Pro ladica

**6071348** Šablona za označavanje Dynapro/Dynamoov

JM kom

**Br. artikla** **Opis artikla**

**6079874** Šablona za označavanje bušenja prihvatnika fronte Dynapro/Dynamoov

JM kom

**Br. artikla** **Opis artikla**

**6070545** Šablona za označavanje fronti Vionaro ladica i stabilizatora za visoke fronte

JM kom

**Br. artikla** **Opis artikla**

**6074770** Šablona za bušenje spojnih elemenata, dno i fronta

JM kom

**Br. artikla** **Opis artikla**

**6073259** Šablona za frontu i reling kod Nova Pro ladica

JM kom

