





## Okovi

2 >

<b>01</b>	Alati i pribor	150	<b>07</b>	Noge za namještaj, kotačići i uredski program	306	<b>12</b>	Sokli, zidne letve i prateći pribor	402
<b>02</b>	Alu klizna vrata i okvirnice	160	<b>08</b>	Okov za vrata i sanitarne kabine	322	<b>13</b>	Spojnice, šarniri i podizni sustavi	414
<b>03</b>	Garderobni i okov za krevete	196	<b>09</b>	Pričvrсна tehnika, ljepila, silikoni i čistila	334			
<b>04</b>	Izvlačne košare i prateći program za kuhinje	214	<b>10</b>	Rasvjeta	352			
<b>05</b>	Konstruktivni i spojni okov	230	<b>11</b>	Ručkice i vješalice	370			
<b>06</b>	Ladice i vodilice	256						

# 2.01

## Alati i pribor



# Električni alati

**Br. artikla**   **Opis artikla**

**6024020** Bosch GSR 10,8-2-Li, aku bušilica/izvijač (2x1,5 Ah, punjač)

JM kom

**Br. artikla**   **Opis artikla**

**6024022** Bosch GSR 1800-Li Prof., aku bušilica/izvijač 18V (2x1,5 Ah, punjač, kovčeg)

JM kom

**Br. artikla**   **Opis artikla**

**6024021** Bosch GSB 13 RE udarna bušilica 600W

JM kom

**Br. artikla**   **Opis artikla**

**6010056** Makita brus. vibrac. B03710 (190W, 93x185mm)

JM kom

**Br. artikla**   **Opis artikla**

**6010057** Makita brus. ekcentar B06030 (310W, 150mm)

JM kom

**Br. artikla**   **Opis artikla**

**6010013** Makita bušilica 6413 (450W, 10mm.bsz.l/r)

JM kom

**Br. artikla**   **Opis artikla**

**6010820** Makita aku buš-izv DF457DWE (18V, 1.3Ah, Li-ion)

JM kom





Br. artikla	Opis artikla
6010066	Makita aku buš.-izv. DF330DWLE (10.8V, Li-Ion)
	JM kom



Br. artikla	Opis artikla
6010045	MAKITA glodalica za lamele "keksarica" PJ7000J (590W, 100 mm)
	JM kom



Br. artikla	Opis artikla
6010023	Makita ubodna pila 4327 (450W.elek)
	JM kom



Br. artikla	Opis artikla
6010032	Makita ubodna pila 4351 FCT (720W)
	JM kom

## Ručni alati



Br. artikla	Opis artikla
6022500	Bosch laserski daljinomjer GLM 30
	JM kom



Br. artikla	Opis artikla
6121115	Svrdlo za drvo šarnir 15 mm
6121120	Svrdlo za drvo šarnir 20 mm
6121135	Svrdlo za drvo šarnir 35 mm
	JM kom



Br. artikla	Opis artikla
6121001	Svrdlo za drvo Ø 3x30 mm
6121002	Svrdlo za drvo Ø 4x40 mm
6121003	Svrdlo za drvo Ø 5x45 mm
6121004	Svrdlo za drvo Ø 6x50 mm
6121006	Svrdlo za drvo Ø 8x65 mm
6121008	Svrdlo za drvo Ø 10x75 mm
6121009	Svrdlo za drvo Ø 12x95 mm
	JM kom



Cijene artikala dostupne su skeniranjem QR koda ili na web stranici [www.elgrad.hr](http://www.elgrad.hr)



**Br. artikla** **Opis artikla**

**6110051** BGS stezna glava 13mm, 1/2"  
+ SDS adapter, 9937

JM kom

**Br. artikla** **Opis artikla**

**6110052** BGS kutna glava, 4847

JM kom

**Br. artikla** **Opis artikla**

**6110053** BGS kutni nastavak, 20801

JM kom

**Br. artikla** **Opis artikla**

**6110076** Makita kruna bimetal 60 mm D-25688

**6110077** Makita držač bim. krune  
32-152mm D-17186

**6110078** Makita kruna bimetal 80 mm D-33869

JM kom

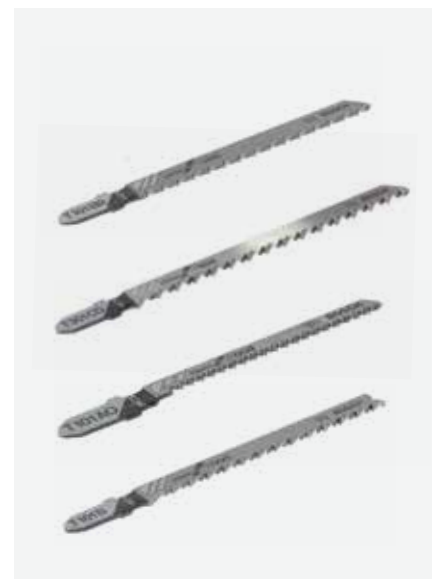
**Br. artikla** **Opis artikla**

**6023200\*** 2,5 x 74 mm - T101BR - tvrdo i meko drvo,  
oplemenjena iverica 3-30 mm - fini rez

**6023201** 3 x 91 mm T301CD - tvrdo i meko drvo,  
oplemenjena iverica 10-65 mm - za deblje ploče

**6023202** 1,4 x 56 mm T101A0 - tvrdo i meko drvo,  
oplemenjena iverica 1.5 - 15 mm za krivolinijski  
rez

**6023203** 2,5 x 74 mm T101B - tvrdo i meko drvo,  
oplemenjena iverica 3-30 mm,  
PVC i Epoxy cijevi do Ø30 mm

JM pak \*set = 5 kom

**Br. artikla** **Opis artikla**

**6023150** Bosch 32-dijelni set bitova izvijača PRO

JM set

**Br. artikla** **Opis artikla**

**6110002** Makita set 28-dij. svrdla i bitovi, P-64808

JM set



**Br. artikla** Opis artikla**6023001** BIT ExtraHard PZ1x25 mm, Bosch**6023002** BIT ExtraHard PZ2x25 mm, Bosch**6023003** BIT ExtraHard PZ3x25 mm, Bosch

JM kom

**Br. artikla** Opis artikla**6023010** BIT INBUS 3, 1/4", l = 25 mm**6023011** BIT INBUS 4, 1/4"

JM kom

**Br. artikla** Opis artikla**6110060** BGS magnetni držač bitova

JM kom

**Br. artikla** Opis artikla**6021120** Strugač PVC s nožem

JM kom

**Br. artikla** Opis artikla**6110061** BGS probijač rupa 35 mm, 562**6040126** Graničnik bušenja za svrdlo ø5 mm

JM kom

**Br. artikla** Opis artikla**6121040** Graničnici dubine bušenja, ø 6-8-10 mm (set)

JM set

**Br. artikla** Opis artikla**6121041** Označivač ø 6 mm, 4/1**6121042** Označivač ø 8 mm, 4/1**6121043** Označivač ø 10 mm, 4/1

JM set set = 4 kom

**Br. artikla** Opis artikla**6040100** TCT-Bormax set svrdala za drvo ø 15,20,25,30 i 35 mm**6040101** TCT-Bormax svrdlo za drvo ø 15 mm**6040102** TCT-Bormax svrdlo za drvo ø 20 mm**6040103** TCT-Bormax svrdlo za drvo ø 35 mm

JM kom



**Br. artikla** **Opis artikla**

**6040110** Set svrdala za drvo  $\varnothing$  3,4,5,6 i 8 mm sa bit prihvatom

JM kom

**Br. artikla** **Opis artikla**

**6040113** HSS svrdlo za drvo  $\varnothing$  3 mm

**6040114** HSS svrdlo za drvo  $\varnothing$  4 mm

**6040115** HSS svrdlo za drvo  $\varnothing$  5 mm

**6040118** HSS svrdlo za drvo  $\varnothing$  8 mm

**6040119** HSS svrdlo za drvo  $\varnothing$  9 mm

**6040120** HSS svrdlo za drvo  $\varnothing$  10 mm

**6040121** HSS svrdlo za drvo  $\varnothing$  11 mm

**6040122** HSS svrdlo za drvo  $\varnothing$  11,5 mm

**6040123** HSS svrdlo za drvo  $\varnothing$  12 mm

**6040124** HSS svrdlo za drvo  $\varnothing$  14 mm

**6040125** Set svrdala za drvo  $\varnothing$  3,4,5,6 i 8 mm sa cilindričnim prihvatom

JM kom

**Br. artikla** **Opis artikla**

**6040128** Rezervno svrdlo za predbušenje,  $\varnothing$  2,75 mm

**6040129** Svrdlo za predbušenje sa vodilicom

JM kom

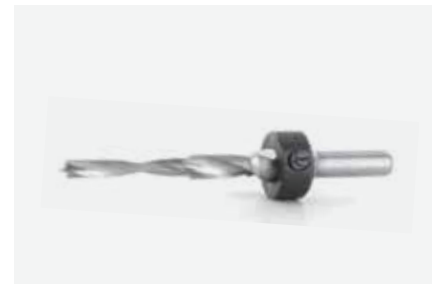
**Br. artikla** **Opis artikla**

**6040130** Svrdlo za konfirmat vijke

JM kom

**Br. artikla** **Opis artikla**

**6040131** Strojni upuštač  $\varnothing$  16 mm

JM kom

**Br. artikla** **Opis artikla**

**6040134** Strojni upuštač  $\varnothing$  16 mm sa bit prihvatom

JM kom

**Br. artikla** **Opis artikla**

**6040135** Strojni upuštač  $\varnothing$  16 mm za svrdlo  $\varnothing$  5 mm

JM kom





**Br. artikla** Opis artikla

**6040139** Ručni upuštač ø 16 mm,  
plastična drška

JM kom

**Br. artikla** Opis artikla

**6040142** Krunska pila sa TM zubima ø60 mm

**6040144** Krunska pila sa TM zubima ø80 mm

**6040146** Krunska pila sa TM zubima ø105 mm

**6040148** Krunska pila sa TM zubima ø133 mm

**6040150** Nosač krunske pile sa izbacivačem

JM kom

**Br. artikla** Opis artikla

**6040151** Ravno glodalo dvoperno ø 8 mm,  
L= 51mm, B= 19mm

**6040152** Ravno glodalo dvoperno ø 10 mm,  
L= 51mm, B= 19mm

**6040153** Ravno glodalo dvoperno ø 12 mm,  
L= 51mm, B= 19mm

**6040154** Ravno glodalo dvoperno ø 14 mm,  
L= 51mm, B= 19mm

**6040155** Ravno glodalo dvoperno ø 16 mm,  
L= 51mm, B= 19mm

**6040156** Ravno glodalo dvoperno ø 12 mm dulje, L= 63mm,  
B= 32mm

JM kom

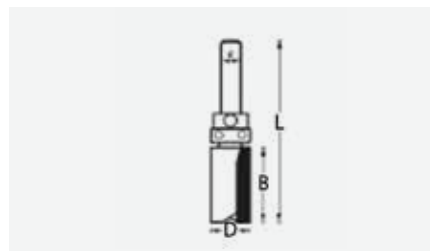
**Br. artikla** Opis artikla

**6040159** Kopirno glodalo ø 15,9 mm, ležaj gore,  
L= 63mm, B= 25,4 mm

JM kom

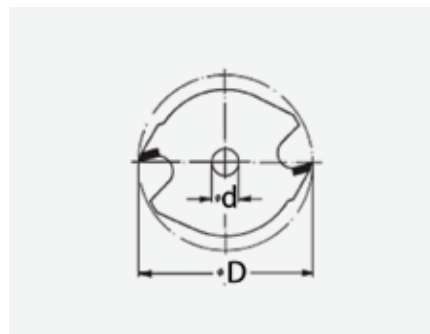
**Br. artikla** Opis artikla

**6040162** Pilasto glodalo  
B=2,5 mm, D= 40 mm, d= 6,35 mm

**6040163** Pilasto glodalo  
B= 3 mm, D= 40mm, d= 6,35mm

**6040164** Pilasto glodalo  
B=3,5 mm, D= 40mm, d= 6,35 mm

**6040165** Pilasto glodalo  
B=4 mm, D= 40mm, d=6,35 mm

JM kom

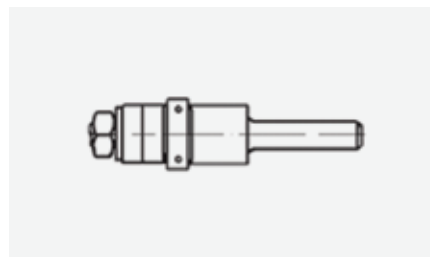
**Br. artikla** Opis artikla

**6040169** Nosač pilastog glodala sa ležajem,  
D= 15,9mm, B= 58mm

JM kom

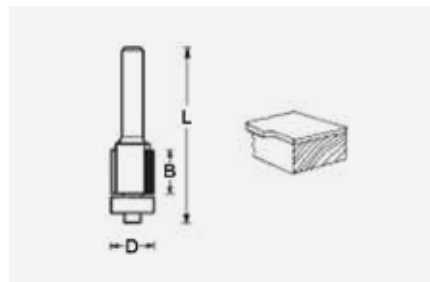
**Br. artikla** Opis artikla

**6040172** Kopirno glodalo ø 12,7 mm, l=12,7 mm, ležaj  
dolje, B=12,7 mm, L= 60mm

**6040173** Kopirno glodalo ø 12,7 mm, l=25,4 mm, ležaj  
dolje, B= 25,4mm, L=70mm

JM kom

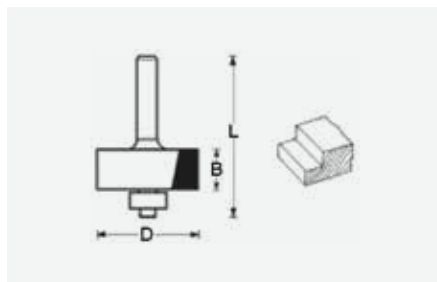

# Šablone

**Br. artikla Opis artikla**

**6040175** Glodalo za leđa  $\varnothing$  31,7 mm sa ležajem,  
B= 12,7 mm, L=51 mm

JM kom

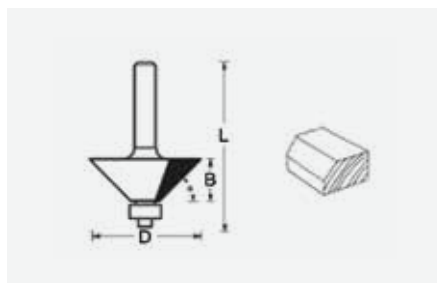
**Br. artikla Opis artikla**

**6040176** Glodalo 45° sa ležajem,  
D=31,8mm, B=12,7mm, L=53mm

JM kom

**Br. artikla Opis artikla**

**6040181** Glodalo r=3 mm sa ležajem,  
D= 18,7 mm, B= 9,5mm, L= 49 mm

**6040182** Glodalo r=4 mm sa ležajem,  
D=20,7 mm, B=9,5mm, L=49 mm

**6040183** Glodalo r=6,4 mm sa ležajem,  
D= 25,4mm, B= 12,7mm, L=51mm

**6040184** Glodalo r=8 mm sa ležajem,  
D= 28,6mm, B= 12,7mm, L=51mm

JM kom

**Br. artikla Opis artikla**

**6121045** Šablona za tiplanje, PVC Bosch

JM kom

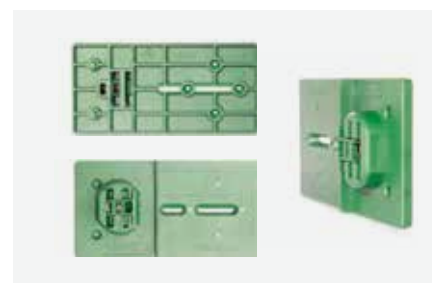
**Br. artikla Opis artikla**

**6075865** Šablona za Grass spojnice i pločice

JM kom

**Br. artikla Opis artikla**

**6075776** Šablona za bušenje Tiomos i Nexis spojnica,  
45/9,5

JM kom



**Br. artikla** Opis artikla

**6072050** Šablona za označavanje fronti Nova Pro ladica, h=90 i h=122

**6071908** Šablona za označavanje fronti Nova Pro ladica, h=186 i h=250

JM kom

**Br. artikla** Opis artikla

**6074770** Šablona za bušenje spojnih elemenata, dno i fronta

JM kom

**Br. artikla** Opis artikla

**6071346** Šablona za označavanje Nova Pro ladica

**6071348** Šablona za označavanje Dynapro/Dynamoov

JM kom

**Br. artikla** Opis artikla

**6073259** Šablona za frontu i reling kod Nova Pro ladica

JM kom

**Br. artikla** Opis artikla

**6079874** Šablona za označavanje bušenja prihvatnika fronte Dynapro/Dynamoov

JM kom

**Br. artikla** Opis artikla

**6070545** Šablona za označavanje fronti Vionaro ladica i stabilizatora za visoke fronte

JM kom



